

GG 1669 - Frameless Glass to Glass Hinged Door and Panels

Features:

- Dual swing option available. (Swing out standard)
- 6" C-pull handle included. (Upgrades available)
- 9/16" X 5/8" standard wall channels.
- Delfector sweep and "L" vinyl to seal the unit door.
- Heavy duty hinges for large doors required (30"+).
- Wall channel can be replaced with clips (contact for more info).

Configurations:

- Consists of single door and two neo panels.

Glass coating option:

- Diamon-Fusion treatment helps protect the build up of soap scum and hard water deposits and reduces cleaning time by 50%. Simply wipe down with a washcloth or squeegee after showering.

Codes/Standards

Tempered Glass
ANSI Z97.1
16 CFR 1201

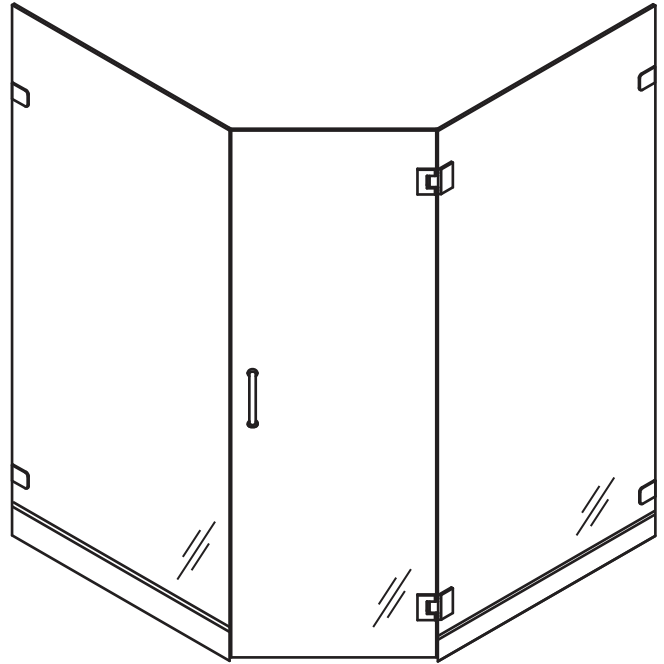

• Material

High polished anodized aluminum.

• Colors

Available in Polished Chrome, Satin Nickel, Gold, Painted colors (6), available upon request

• Century Bathworks 3 year Limited Warranty

See website or call for detailed information.

• Specification

Model Number: GG-1669
Door Type: Single door and two neo panels.
Opening Style: Hinged
Glass thickness: 3/8" or 1/2"
Assembly: Read installation guide
Country of origin: United States of America

• For residential and hospitality use

GG 1669 - Frameless Glass to Glass Hinged Door and Panels

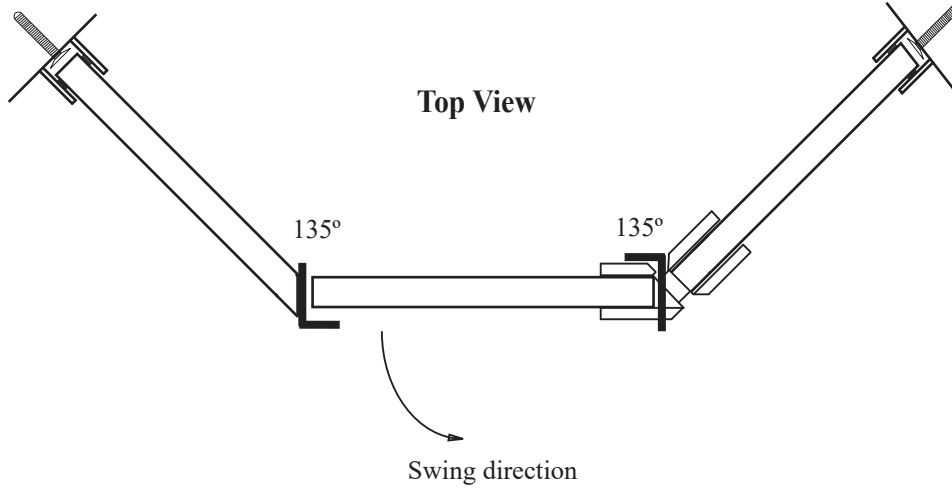

Glass to glass Hinge

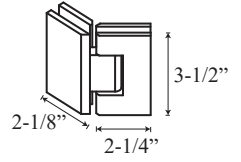

C-Pull Handle

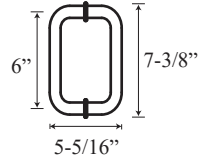

Wall Channel

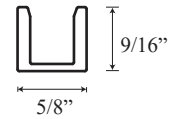

Deflector Sweep

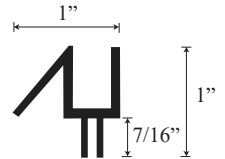

Section or Side view

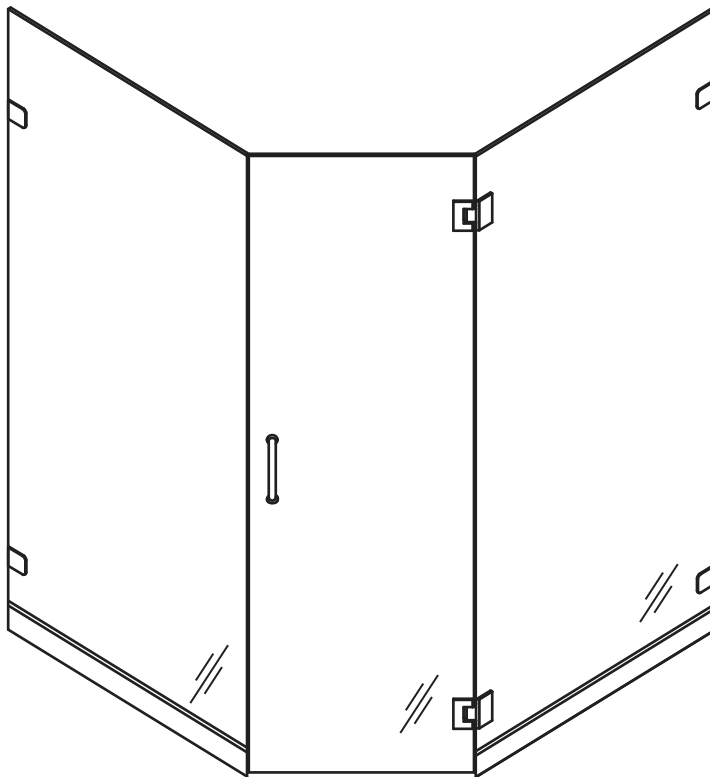

"L" Vinyl

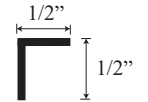

Wall Clip

