

# CENTEC

## PRICE BOOK

Prices shown reflect our most current prices. Due to ongoing market fluctuations, prices are subject to change without prior notice.



SUMMARY ..... 3

BIFOLD (1/4") ..... 4 - 5

SELECT ..... 6

PREMIER ..... 7

CT/CS MODELS ..... 8 - 20

CH MODELS ..... 21 - 23

CHX MODELS ..... 24 - 26

GLASS UPGRADES ..... 27 - 28

HANDLES ..... 29

TOWEL BARS ..... 30

DECORATIVE FINISHES ..... 31

CUSTOM GLASS FABRICATION ..... 32

FILLERS ..... 33

**TOP ROLLING SLIDER (BARN DOOR)**

Centec Select
Centec Select w/ 90° Return
Centec Premier

**SOLID BRASS FRAMELESS SLIDER MODELS**

CT	Tub Enclosure
CS	Stall Enclosure
CT-670	Tub Enclosure w/ Inline Panel
CS-1670	Stall Enclosure w/ Inline Panel
CT-636	Tub Enclosure w/ 90° return
CS-1648	Stall Enclosure w/ 90° return

**SEMI-FRAMELESS HINGE ENCLOSURES**

Hinge/Mount Type:	CH	CHX
	Aluminum Continuous Pivot Hinge	Aluminum Patch Hinge (Crossover Model)
	Hinge along entire length of door and attaches to channel	Patch hinges attach glass to wall channel
CONFIGURATIONS		
36		
64		
70	X	X
71		
72		
1627	X	X
1628	X	X
1629		
1630	X	X
1631	X	X
1669	X	X
1669 2/3	X	X

The table above is meant to display all available Centec hinge door models. An “X” indicates that the configuration is available for the corresponding hinge type. The following pages include pricing for the majority of models, though some have been excluded to simplify the book. Please contact us if you would like pricing for any enclosure that is not included in the book- we would be happy to help.

## BIFOLD MODELS

### STANDARD FEATURES ON BIFOLD MODELS

- Bifold Doors operate with the ease of a conventional door
- Handle swings in a natural, ergonomic path
- Slim 1" square brass header
- Ideal for tight spaces-Easily clears vanities and toilets
- Ideal for ADA applications
- Fully opened doors create a safer environment while bathing young children in bathtub applications

Available in Standard Paint

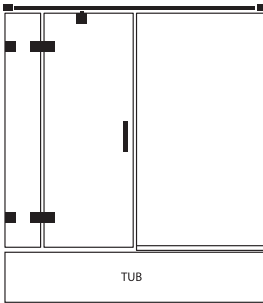

BF-1627-BIFOLD 1/4" GLASS				
Finish	Width	48"	54"	60"
Chrome	62" Height	\$2,453	\$2,568	\$2,687
Satin Nickel	62" Height	\$2,580	\$2,697	\$2,814
Matte Black	62" Height	\$2,511	\$2,628	\$2,745

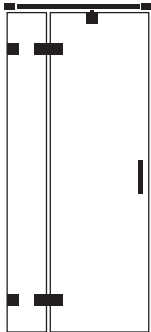

BF-70-BIFOLD 1/4" GLASS							
Finish	Width	20"	22"	24"	26"	28"	30"
Chrome	76" Height	\$1,728	\$1,759	\$1,806	\$1,854	\$1,900	\$1,949
Satin Nickel	76" Height	\$1,855	\$1,885	\$1,932	\$1,980	\$2,027	\$2,075
Matte Black	76" Height	\$1,784	\$1,817	\$1,863	\$1,912	\$1,958	\$1,939

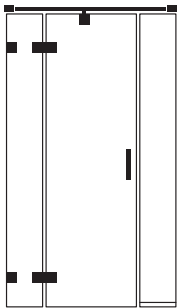

BF-1627-BIFOLD 1/4" GLASS									
Finish	Width	30"	34"	38"	42"	46"	50"	54"	60"
Chrome	76" Height	\$2,233	\$2,323	\$2,417	\$2,512	\$2,608	\$2,703	\$2,799	\$2,942
Satin Nickel	76" Height	\$2,360	\$2,449	\$2,544	\$2,639	\$2,735	\$2,829	\$2,905	\$3,067
Matte Black	76" Height	\$2,290	\$2,379	\$2,475	\$2,570	\$2,666	\$2,760	\$2,855	\$2,997

Anodized aluminum may vary in shade and color among extrusions. Color variance is considered within factory tolerances in the Anodizing Industry.

## BIFOLD MODELS

### STANDARD FEATURES ON BIFOLD MODELS

- Bifold Doors operate with the ease of a conventional door
- Handle swings in a natural, ergonomic path
- Slim 1" square brass header
- Ideal for tight spaces-Easily clears vanities and toilets
- Ideal for ADA applications
- Fully opened doors create a safer environment while bathing young children in bathtub applications

Available in Standard Paint

\* Buttress available

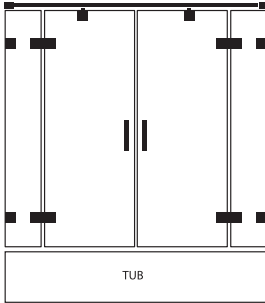

BF-1629-BIFOLD 1/4" GLASS (ADA)				
Finish	Width	48"	54"	60"
Chrome	62" Height	\$3,177	\$3,235	\$3,353
Satin Nickel	62" Height	\$3,284	\$3,400	\$3,515
Matte Black	62" Height	\$3,187	\$3,302	\$3,419

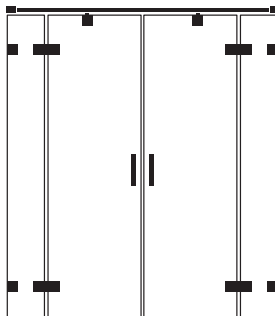

BF-1629-BIFOLD 1/4" GLASS (ADA)							
Finish	Width	40"	44"	48"	52"	56"	60"
Chrome	76" Height	\$3,197	\$3,292	\$3,387	\$3,481	\$3,576	\$3,671
Satin Nickel	76" Height	\$3,360	\$3,456	\$3,551	\$3,646	\$3,741	\$3,836
Matte Black	76" Height	\$3,264	\$3,359	\$3,455	\$3,549	\$3,644	\$3,741

Anodized aluminum may vary in shade and color among extrusions. Color variance is considered within factory tolerances in the Anodizing Industry.

# HEAVY GLASS TOP ROLLING SLIDER

## STANDARD FEATURES ON CENTEC SELECT

- Top rolling 3/8" clear heavy glass sliding enclosure
- 3/4" stainless steel header bar
- 4 stainless steel rollers with concealed ball bearings
- Standard back to back 16" ladder pull handles- 12" center-to-center hole location
- Fixed panel opposite sliding panel with a 2 1/2" overlap
- Water dam
- U channel under panels
- For 90° return model: stationary wall clips on return panel & top mounted corner clip

Available in Standard Paint

\* Buttress available

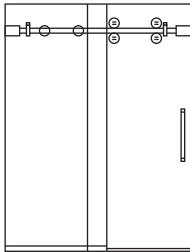

CENTEC SELECT			
MIN TO MAX WIDTH	HEIGHT	SATIN STAINLESS	POLISHED STAINLESS
46" TO 54"	76"	\$2,920	\$3,133
54" TO 57"		\$3,333	\$3,546
57" TO 62"		\$3,514	\$3,728
54" TO 57"	62 3/4"	\$2,882	\$3,095
57" TO 62"	62 3/4"	\$3,126	\$3,339

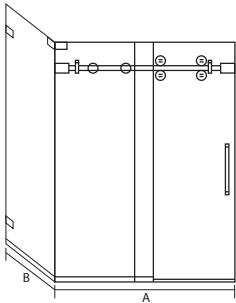

CENTEC SELECT WITH 90° RETURN PANEL			
MIN TO MAX WIDTH	HEIGHT	SATIN STAINLESS	POLISHED STAINLESS
46" TO 54" w/ return up to 36"	76"	\$4,943	\$5,156
46" TO 54" w/ return up to 42"		\$5,158	\$5,371
46" TO 54" w/ return up to 48"		\$5,375	\$5,588
54" TO 57" w/ return up to 36"		\$5,087	\$5,300
54" TO 57" w/ return up to 42"		\$5,302	\$5,516
54" TO 57" w/ return up to 48"		\$5,518	\$5,731
57" TO 62" w/ return up to 36"		\$5,231	\$5,414
57" TO 62" w/ return up to 42"		\$5,447	\$5,660
57" TO 62" w/ return up to 48"		\$5,662	\$5,875

Anodized aluminum may vary in shade and color among extrusions. Color variance is considered within factory tolerances in the Anodizing Industry.

# HEAVY GLASS TOP ROLLING BYPASS SLIDER

## STANDARD FEATURES ON CENTEC PREMIER

- Top rolling 3/8" clear heavy glass sliding enclosure
- 2" header bar
- Tear drop shaped hardware conceals roller mechanism
- Adjustable Rollers allow outages up to 3/8" on the wall and 1/4" on the base
- 2" recessed cup handle. Other hardware options are available- call for pricing.
- Recommended overlap between the 2 doors is 2-4"
- Water dam included under door
- Cushioned vinyl protects glass edge
- Custom sizes available with a max width of 66" and a max height of 80"
- Soft Close feature

**Available in Standard Paint**

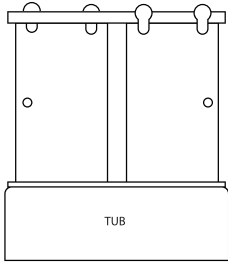

CENTEC PREMIER, BYPASS TUB					
MIN TO MAX WIDTH	HEIGHT	SATIN STAINLESS	POLISHED STAINLESS	OIL RUBBED BRONZE, MATTE BLACK	SATIN GOLD
57-59"	62"	\$2,069	\$2,113	\$2,326	\$3,323
57-59"	66"	\$2,116	\$2,157	\$2,371	\$3,354

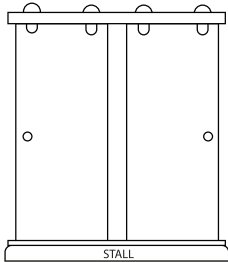

CENTEC PREMIER, STALL BYPASS					
MIN TO MAX WIDTH	HEIGHT	SATIN STAINLESS	POLISHED STAINLESS	OIL RUBBED BRONZE, MATTE BLACK	SATIN GOLD
45 - 47"	72"	\$1,866	\$1,911	\$2,274	\$2,664
57 - 59"		\$2,184	\$2,225	\$2,438	\$3,401
45 - 47"	76"	\$1,902	\$1,948	\$2,309	\$3,317
57 - 59"		\$2,229	\$2,270	\$2,484	\$3,433

Anodized aluminum may vary in shade and color among extrusions. Color variance is considered within factory tolerances in the Anodizing Industry.

## SEMI-FRAMELESS BYPASS SLIDERS

### STANDARD FEATURES ON CENTEC CT / CS

- Round or Flat Header. Round will be supplied unless specified
- \*\*Crown Molding Header Available at an additional charge. Available in Silver, Gold, Satin Nickel, & Oil Rubbed Bronze Finishes only. Crown header not available in a reinforced header.
- Pricing shown assumes Clear tempered glass (1/4" or 3/8" as indicated) (All in-line & return panels are 1/4" glass)
- Standard finish is chrome anodized aluminum, but other finishes are available
- Polished Nickel finish only available with a flat header
- Anti-jump safety clips
- Modern Towel Bars come standard
- Fillers are available for out of plumb and out of level conditions. See page 30 for details.
- Consult factory when overlap is at a minimum or maximum range. Excessive overlap will decrease pass thru.
- Custom configurations are available for most bypass units, including additional inline panels, buttress panels, angle cut panels or doors to follow the slope of the ceiling, etc. Please contact us for details.

Available in Standard Paint

\* Buttress available

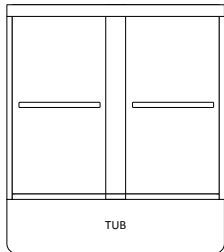

1/4 BUBBLE (STOCK)  
WHILE SUPPLIES LAST

CT- BYPASS TUB W/ 1/4" GLASS							
	MODEL	MIN TO MAX WIDTH	HEIGHT	SILVER	GOLD	SATIN NICKEL	STANDARD PAINT
1/4" CLEAR	CT 4 *	42 1/2" TO 48"	57 3/4"	\$1,011	\$1,112	\$1,177	\$1,539
	CT 4.5	48" TO 53 1/2"					
	CT 5 *	54" TO 59 1/2"					
	CT 5.5 *	60" TO 65 1/2"	57 3/4"	\$1,058	\$1,158	\$1,223	\$1,584
	CT 6 *	66" TO 71 1/2"	57 3/4"	\$1,103	\$1,203	\$1,268	\$1,629
	CT 51-56 *	48" TO 53 1/2"	56"	\$984	\$1,084	\$1,149	\$1,510
	CT 56-56	52" TO 57"					
1/4" BUBBLE	CT 4	42 1/2" TO 48"	57 3/4"	\$1,194	\$1,295	\$1,360	\$1,722
	CT 4.5	48" TO 53 1/2"	57 3/4"	\$1,194	\$1,295	\$1,360	\$1,722
	CT 5.5	60" TO 65 1/2"	57 3/4"	\$1,241	\$1,341	\$1,406	\$1,767
	CT 6	66" TO 71 1/2"	57 3/4"	\$1,286	\$1,386	\$1,451	\$1,812
	CT 51-56	48" TO 53 1/2"	56"	\$1,167	\$1,267	\$1,332	\$1,693

\*Available in 1 hole glass with knob  Limited Inventory

Standard Colors include: Pearl White, Oil Rubbed Bronze, Matte Black. Custom color matching is also available for most Centec models- please call for pricing.

Anodized aluminum may vary in shade and color among extrusions.  
Color variance is considered within factory tolerances in the Anodizing Industry.

Available in Standard Paint \* Buttress available

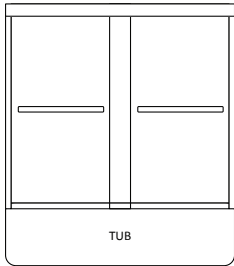

**CTX- TALLER BYPASS TUB W/ 1/4" GLASS**

	MODEL	MIN TO MAX WIDTH	HEIGHT	SILVER	GOLD	SATIN NICKEL	STANDARD PAINT
1/4" CLEAR	CTX 4.5 *	48" TO 53 1/2"	62 3/4"	\$1,035	\$1,135	\$1,224	\$1,561
	CTX 5 *	54" TO 59 1/2"					
	CTXX 5	54" TO 59 1/2"	66"	\$1,084	\$1,169	\$1,288	\$1,585
	CTX 5.5	60" TO 65 1/2"	62 3/4"	\$1,131	\$1,204	\$1,320	\$1,657
	CTX 6 *	66" TO 71 1/2"					
1/4" BUBBLE	CTXX 5	54" TO 59 1/2"	66"	\$1,267	\$1,352	\$1,471	\$1,768
	CTX 5	54" TO 59 1/2"	62 3/4"	\$1,218	\$1,318	\$1,407	\$1,744
	CTX 5.5	60" TO 65 1/2"	62 3/4"	\$1,314	\$1,387	\$1,503	\$1,840
	CTX 6	66" TO 71 1/2"	62 3/4"	\$1,314	\$1,387	\$1,503	\$1,840

\*Available in 1 hole glass with knob  Limited Inventory

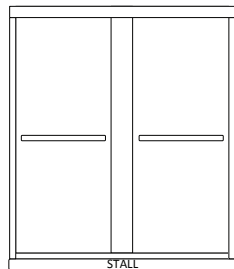

**CS- STALL BYPASS W/ 1/4" GLASS**

	MODEL	MIN TO MAX WIDTH	HEIGHT	SILVER	GOLD	SATIN NICKEL	STANDARD PAINT
1/4" CLEAR	CS 3.5 *	36" TO 41 1/2"	70 3/4"	\$1,025	\$1,112	\$1,229	\$1,508
	CS 4 *	42" TO 47 1/2"					
	CS 4.5	48" TO 53 1/2"	70 3/4"	\$1,135	\$1,223	\$1,338	\$1,612
	CS 5 *	54" TO 59 1/2"					
	CS 5.5	60" TO 65 1/2"	70 3/4"	\$1,217	\$1,304	\$1,420	\$1,682
	CS 4466	40" TO 45"	66"	\$1,014	\$1,101	\$1,218	\$1,481
1/4" BUBBLE	CS 3.5	36" TO 41 1/2"	70 3/4"	\$1,339	\$1,426	\$1,543	\$1,822
	CS 4	42" TO 47 1/2"		\$1,339	\$1,426	\$1,543	\$1,822
	CS 4466	40" TO 45"	66"	\$1,328	\$1,415	\$1,532	\$1,795

\*Available in 1 hole glass with knob  Limited Inventory

Anodized aluminum may vary in shade and color among extrusions. Color variance is considered within factory tolerances in the Anodizing Industry.

Available in Standard Paint

\* Buttress available

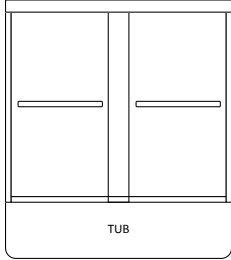

CT-BYPASS TUB W/ 3/8" GLASS							
	MODEL	MIN TO MAX WIDTH	HEIGHT	SILVER	GOLD	SATIN NICKEL	STANDARD PAINT
3/8" CLEAR	CT 4	42 1/2" TO 48"	57 3/4"	\$1,315	\$1,482	\$1,513	\$1,831
	CT 4.5	48" TO 53 1/2"					
	CT 5 *	54" TO 59 1/2"		\$1,435	\$1,540	\$1,634	\$1,894
	CT 5.5	60" TO 65 1/2"					
	CT 6	66" TO 71 1/2"	56"	\$1,507	\$1,610	\$1,705	\$1,958
	CT 51-56	48" TO 53 1/2"		\$1,275	\$1,376	\$1,470	\$1,792
	CT 56-56	52" TO 57"					
3/8" BUBBLE	CT 4	42 1/2" TO 48"	57 3/4"	\$1,613	\$1,780	\$1,811	\$2,129
	CT 5	54" TO 59 1/2"		\$1,613	\$1,780	\$1,811	\$2,129
	CT 5.5	60" TO 65 1/2"		\$1,733	\$1,838	\$1,932	\$2,192
	CT 6	66" TO 71 1/2"		\$1,805	\$1,908	\$2,003	\$2,256
	CT 51-56	48" TO 53 1/2"	56"	\$1,573	\$1,674	\$1,768	\$2,090
	CT 56-56	52" TO 57"		\$1,573	\$1,674	\$1,768	\$2,090

\*Available in 1 hole glass with knob

Limited Inventory

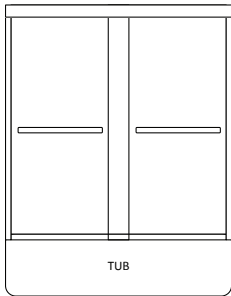

CTX-TALLER BYPASS TUB W/ 3/8" GLASS							
	MODEL	MIN TO MAX WIDTH	HEIGHT	SILVER	GOLD	SATIN NICKEL	STANDARD PAINT
3/8" CLEAR	CTX 4.5	48" TO 53 1/2"	62 3/4"	\$1,464	\$1,567	\$1,662	\$1,916
	CTX 5 *	54" TO 59 1/2"					
	CTX 5 *	54" TO 59 1/2"	66"	\$1,504	\$1,607	\$1,703	\$1,956
	CTX 5.5	60" TO 65 1/2"	62 3/4"	\$1,614	\$1,717	\$1,813	\$2,068
	CTX 6	66" TO 71 1/2"					
3/8" BUBBLE	CTX 5	54" TO 59 1/2"	62 3/4"	\$1,802	\$1,905	\$2,001	\$2,254
	CTX 5.5	60" TO 65 1/2"	62 3/4"	\$1,762	\$1,865	\$1,960	\$2,214
	CTX 5	54" TO 59 1/2"	66"	\$1,912	\$2,015	\$2,111	\$2,366
	CTX 6	66" TO 71 1/2"	62 3/4"	\$1,912	\$2,015	\$2,111	\$2,366

\*Available in 1 hole glass with knob

Limited Inventory

Anodized aluminum may vary in shade and color among extrusions.  
Color variance is considered within factory tolerances in the Anodizing Industry.

Available in Standard Paint

\* Buttress available

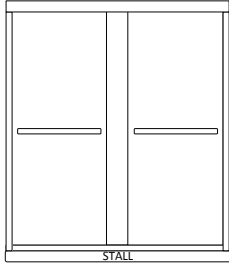

CS- STALL BYPASS W/ 3/8" GLASS							
	MODEL	MIN TO MAX WIDTH	HEIGHT	SILVER	GOLD	SATIN NICKEL	STANDARD PAINT
3/8" CLEAR	CS 3.5	36" TO 41 1/2"	70 3/4"	\$1,483	\$1,585	\$1,680	\$1,933
	CS 4 *	42" TO 47 1/2"					
	CS 4.5	48" TO 53 1/2"		\$1,605	\$1,707	\$1,801	\$2,055
	CS 5 *	54" TO 59 1/2"					
	CS 5.5	60" TO 65 1/2"	\$1,691	\$1,791	\$1,887	\$2,141	
	CS 4466	40" TO 45"	66"	\$1,330	\$1,431	\$1,526	\$1,780
3/8" BUBBLE	CS 4	42" TO 47 1/2"	70 3/4"	\$1,855	\$1,957	\$2,052	\$2,305
	CS 4.5	48" TO 53 1/2"		\$1,977	\$2,079	\$2,173	\$2,453
	CS 5.5	60" TO 65 1/2"		\$2,063	\$2,163	\$2,259	\$2,513
	CS 4466	40" TO 45"	66"	\$1,702	\$1,803	\$1,898	\$2,152

Shaded models indicate that a strengthened header will be used due to excessive weight. This adds 3/8" to Height.

\*Available in 1 hole glass with knob

Limited Inventory

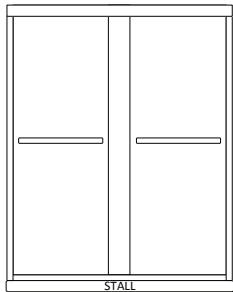

CSX-TALLER STALL BYPASS W/ 3/8" GLASS							
	MODEL	MIN TO MAX WIDTH	HEIGHT	SILVER	GOLD	SATIN NICKEL	STANDARD PAINT
3/8" CLEAR	CSX 3.5	36" TO 41 1/2"	76"	\$1,574	\$1,675	\$1,771	\$2,024
	CSX 4	42" TO 47 1/2"					
	CSX 5 *	54" TO 59 1/2"		\$1,759	\$1,862	\$1,956	\$2,212
	CSX 5.5	60" TO 65 1/2"					

Shaded models indicate that a strengthened header will be used due to excessive weight. This adds 3/8" to Height.

\*Available in 1 hole glass with knob

Anodized aluminum may vary in shade and color among extrusions.  
Color variance is considered within factory tolerances in the Anodizing Industry.

Available in Standard Paint \* Buttruss available

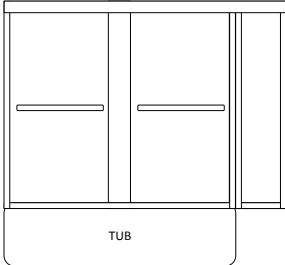

CT-670- BYPASS TUB WITH PANEL W/ 1/4" GLASS							
	MODEL	MIN TO MAX WIDTH	HEIGHT	SILVER	GOLD	SATIN NICKEL	STANDARD PAINT
1/4" CLEAR	CT-670	48" TO 59 1/2" w/Panel up to 12"	57 3/4"	\$1,345	\$1,496	\$1,691	\$2,135
		48" TO 59 1/2" w/Panel up to 18"		\$1,445	\$1,595	\$1,790	\$2,235
		48" TO 59 1/2" w/Panel up to 24"		\$1,561	\$1,712	\$1,907	\$2,345
		60" TO 71 1/2" w/Panel up to 12"		\$1,457	\$1,609	\$1,803	\$2,248
		60" TO 71 1/2" w/Panel up to 18"		\$1,557	\$1,708	\$1,901	\$2,347
		60" TO 71 1/2" w/Panel up to 24"		\$1,676	\$1,826	\$2,021	\$2,466

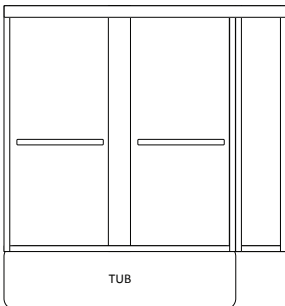

CTX-670- TALLER BYPASS TUB WITH PANEL SIZES W/ 1/4" GLASS							
	MODEL	MIN TO MAX WIDTH	HEIGHT	SILVER	GOLD	SATIN NICKEL	STANDARD PAINT
1/4" CLEAR	CTX-670	48" TO 59 1/2" w/Panel up to 12"	62 3/4"	\$1,384	\$1,535	\$1,729	\$2,174
		48" TO 59 1/2" w/Panel up to 18"		\$1,487	\$1,638	\$1,831	\$2,277
		48" TO 59 1/2" w/Panel up to 24"		\$1,608	\$1,758	\$1,953	\$2,398
		60" TO 71 1/2" w/Panel up to 12"		\$1,500	\$1,656	\$1,792	\$2,290
		60" TO 71 1/2" w/Panel up to 18"		\$1,603	\$1,753	\$1,891	\$2,393
		60" TO 71 1/2" w/Panel up to 24"		\$1,724	\$1,875	\$2,068	\$2,514
	CTXX-670	54" TO 59 1/2" w/Panel up to 12"	66"	\$1,411	\$1,564	\$1,758	\$2,112
		54" TO 59 1/2" w/Panel up to 18"		\$1,517	\$1,668	\$1,861	\$2,307
		54" TO 59 1/2" w/Panel up to 24"		\$1,639	\$1,789	\$1,984	\$2,429

Anodized aluminum may vary in shade and color among extrusions. Color variance is considered within factory tolerances in the Anodizing Industry.

Available in Standard Paint \* Buttruss available

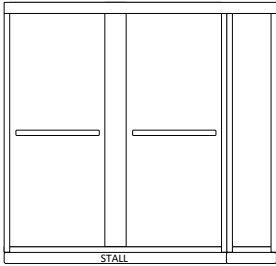

CS-1670- STALL BYPASS WITH PANEL W/ 1/4" GLASS							
	MODEL	MIN TO MAX WIDTH	HEIGHT	SILVER	GOLD	SATIN NICKEL	STANDARD PAINT
1/4" CLEAR	CS-1670	36" TO 47 1/2" w/Panel up to 12"	70 3/4"	\$1,407	\$1,540	\$1,715	\$2,139
		36" TO 47 1/2" w/Panel up to 18"		\$1,506	\$1,638	\$1,813	\$2,245
		36" TO 47 1/2" w/Panel up to 24"		\$1,606	\$1,738	\$1,925	\$2,370
		48" TO 59 1/2" w/Panel up to 12"		\$1,515	\$1,645	\$1,820	\$2,242
		48" TO 59 1/2" w/Panel up to 18"		\$1,613	\$1,745	\$1,920	\$2,314
		48" TO 59 1/2" w/Panel up to 24"		\$1,712	\$1,844	\$2,028	\$2,473
		60" TO 65 1/2" w/Panel up to 12"		\$1,568	\$1,701	\$1,876	\$2,304
		60" TO 65 1/2" w/Panel up to 18"		\$1,667	\$1,799	\$1,975	\$2,409
		60" TO 65 1/2" w/Panel up to 24"		\$1,766	\$1,896	\$2,090	\$2,534

Anodized aluminum may vary in shade and color among extrusions. Color variance is considered within factory tolerances in the Anodizing Industry.

Available in Standard Paint

\* Buttruss available

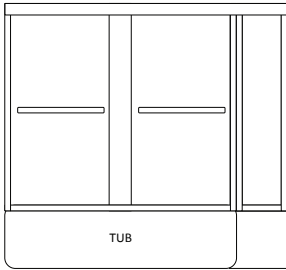

CT-670- BYPASS TUB WITH PANEL W/ 3/8" GLASS							
	MODEL	MIN TO MAX WIDTH	HEIGHT	SILVER	GOLD	SATIN NICKEL	STANDARD PAINT
3/8" CLEAR	CT-670	48" TO 59 1/2" w/Panel up to 12"	57 3/4"	\$1,781	\$1,913	\$2,126	\$2,571
		48" TO 59 1/2" w/Panel up to 18"		\$1,928	\$2,073	\$2,263	\$2,687
		48" TO 59 1/2" w/Panel up to 24"		\$2,019	\$2,164	\$2,354	\$2,778
		60" TO 71 1/2" w/Panel up to 12"		\$1,923	\$2,073	\$2,267	\$2,713
		60" TO 71 1/2" w/Panel up to 18"		\$2,108	\$2,260	\$2,454	\$2,899
		60" TO 71 1/2" w/Panel up to 24"		\$2,263	\$2,403	\$2,594	\$3,020

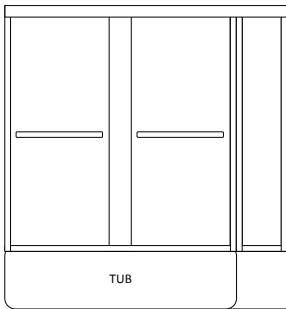

CTX-670- TALLER BYPASS TUB WITH PANEL SIZES W/ 3/8" GLASS							
	MODEL	MIN TO MAX WIDTH	HEIGHT	SILVER	GOLD	SATIN NICKEL	STANDARD PAINT
3/8" CLEAR	CTX-670	48" TO 59 1/2" w/Panel up to 12"	62 3/4"	\$1,843	\$1,983	\$2,176	\$2,622
		48" TO 59 1/2" w/Panel up to 18"		\$2,022	\$2,172	\$2,368	\$2,812
		48" TO 59 1/2" w/Panel up to 24"		\$2,188	\$2,332	\$2,521	\$2,947
		60" TO 71 1/2" w/Panel up to 12"		\$2,074	\$2,206	\$2,381	\$2,775
		60" TO 71 1/2" w/Panel up to 18"		\$2,174	\$2,326	\$2,520	\$2,965
		60" TO 71 1/2" w/Panel up to 24"		\$2,341	\$2,492	\$2,685	\$3,131
	CTXX-670	54" TO 59 1/2" w/Panel up to 12"	66"	\$1,892	\$2,026	\$2,221	\$2,666
		54" TO 59 1/2" w/Panel up to 18"		\$2,067	\$2,219	\$2,412	\$2,858
		54" TO 59 1/2" w/Panel up to 24"		\$2,234	\$2,384	\$2,580	\$3,006

Anodized aluminum may vary in shade and color among extrusions.  
Color variance is considered within factory tolerances in the Anodizing Industry.

Available in Standard Paint \* Buttress available

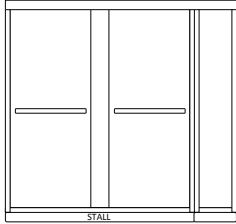

CS-1670- STALL BYPASS WITH PANEL W/ 3/8" GLASS							
	MODEL	MIN TO MAX WIDTH	HEIGHT	SILVER	GOLD	SATIN NICKEL	STANDARD PAINT
3/8" CLEAR	CS-1670	36" TO 47 1/2" w/Panel up to 12"	70 3/4"	\$1,950	\$2,081	\$2,256	\$2,645
		36" TO 47 1/2" w/Panel up to 18"		\$2,065	\$2,195	\$2,370	\$2,759
		36" TO 47 1/2" w/Panel up to 24"		\$2,162	\$2,290	\$2,465	\$2,856
		48" TO 59 1/2" w/Panel up to 12"		\$2,122	\$2,253	\$2,426	\$2,816
		48" TO 59 1/2" w/Panel up to 18"		\$2,232	\$2,363	\$2,536	\$2,926
		48" TO 59 1/2" w/Panel up to 24"		\$2,342	\$2,471	\$2,645	\$3,037
		60" TO 65 1/2" w/Panel up to 12"		\$2,271	\$2,402	\$2,577	\$2,966
		60" TO 65 1/2" w/Panel up to 18"		\$2,381	\$2,511	\$2,686	\$3,076
		60" TO 65 1/2" w/Panel up to 24"		\$2,491	\$2,621	\$2,796	\$3,186

Shaded models indicate that a strengthened header will be used due to excessive weight. This adds 3/8" to Height.

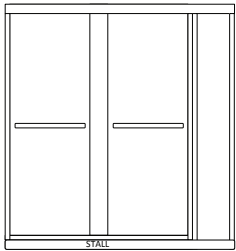

CSX-1670- TALLER STALL BYPASS WITH PANEL W/ 3/8" GLASS							
	MODEL	MIN TO MAX WIDTH	HEIGHT	SILVER	GOLD	SATIN NICKEL	STANDARD PAINT
3/8" CLEAR	CSX-1670	36" TO 47 1/2" w/Panel up to 12"	76"	\$1,963	\$2,105	\$2,296	\$2,721
		36" TO 47 1/2" w/Panel up to 18"		\$2,072	\$2,212	\$2,402	\$2,828
		36" TO 47 1/2" w/Panel up to 24"		\$2,098	\$2,248	\$2,443	\$2,888
		48" TO 59 1/2" w/Panel up to 12"		\$2,140	\$2,243	\$2,470	\$2,899
		48" TO 59 1/2" w/Panel up to 18"		\$2,247	\$2,390	\$2,580	\$3,006
		48" TO 59 1/2" w/Panel up to 24"		\$2,356	\$2,497	\$2,686	\$3,113
		60" TO 65 1/2" w/Panel up to 12"		\$2,293	\$2,436	\$2,519	\$3,081
		60" TO 65 1/2" w/Panel up to 18"		\$2,400	\$2,541	\$2,733	\$3,157
		60" TO 65 1/2" w/Panel up to 24"		\$2,506	\$2,648	\$2,838	\$3,264

Shaded models indicate that a strengthened header will be used due to excessive weight. This adds 3/8" to Height.

Anodized aluminum may vary in shade and color among extrusions. Color variance is considered within factory tolerances in the Anodizing Industry.

Available in Standard Paint

\* Buttruss available

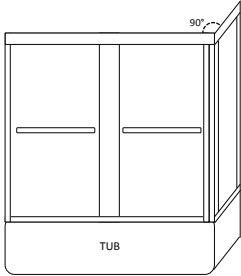

CT-636-BYPASS TUB WITH 90° RETURN PANEL W/ 1/4" GLASS							
	MODEL	MIN TO MAX WIDTH	HEIGHT	SILVER	GOLD	SATIN NICKEL	STANDARD PAINT
1/4" CLEAR	CT-636	Slider 48" TO 59 1/2" return up to 30"	57 3/4"	\$1,740	\$1,882	\$2,072	\$2,497
		Slider 48" TO 59 1/2" return up to 36"		\$1,860	\$2,002	\$2,192	\$2,618
		Slider 60" TO 71 1/2" return up to 30"		\$1,858	\$2,000	\$2,189	\$2,616
		Slider 60" TO 71 1/2" return up to 36"		\$1,980	\$2,121	\$2,310	\$2,737

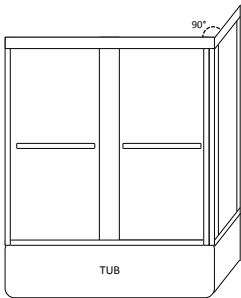

CTX-636-TALLER BYPASS TUB WITH 90° RETURN PANEL W/ 1/4" GLASS							
	MODEL	MIN TO MAX WIDTH	HEIGHT	SILVER	GOLD	SATIN NICKEL	STANDARD PAINT
1/4" CLEAR	CTX-636	Slider 48" TO 59 1/2" return up to 30"	62 3/4"	\$1,830	\$1,970	\$2,161	\$2,587
		Slider 48" TO 59 1/2" return up to 36"		\$1,955	\$2,098	\$2,287	\$2,713
		Slider 60" TO 71 1/2" return up to 30"		\$1,951	\$2,092	\$2,281	\$2,709
		Slider 60" TO 71 1/2" return up to 36"		\$2,076	\$2,220	\$2,408	\$2,836
	CTXX-636	Slider 54" TO 59 1/2" return up to 30"	66"	\$1,872	\$2,015	\$2,205	\$2,629
		Slider 54" TO 59 1/2" return up to 36"		\$2,001	\$2,143	\$2,333	\$2,758

Anodized aluminum may vary in shade and color among extrusions. Color variance is considered within factory tolerances in the Anodizing Industry.

Available in Standard Paint \* Buttress available

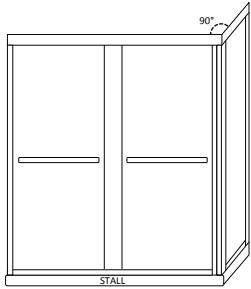

CS-1648-STALL BYPASS WITH 90° RETURN PANEL W/ 1/4" GLASS							
	MODEL	MIN TO MAX WIDTH	HEIGHT	SILVER	GOLD	SATIN NICKEL	STANDARD PAINT
1/4" CLEAR	CS-1648	Slider 36" TO 47 1/2" return up to 30"	70 3/4"	\$1,862	\$2,005	\$2,195	\$2,619
		Slider 36" TO 47 1/2" return up to 36"		\$1,952	\$2,094	\$2,284	\$2,710
		Slider 48" TO 59 1/2" return up to 30"		\$2,004	\$2,155	\$2,349	\$2,784
		Slider 48" TO 59 1/2" return up to 36"		\$2,119	\$2,260	\$2,449	\$2,874
		Slider 60" TO 65 1/2" return up to 30"		\$2,066	\$2,266	\$2,410	\$2,856
		Slider 60" TO 65 1/2" return up to 36"		\$2,188	\$2,338	\$2,533	\$2,972

Anodized aluminum may vary in shade and color among extrusions.  
Color variance is considered within factory tolerances in the Anodizing Industry.

Available in Standard Paint

\* Buttruss available

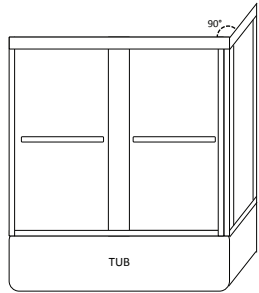

CT-636 BYPASS TUB WITH 90° RETURN PANEL W/ 3/8" GLASS							
	MODEL	MIN TO MAX WIDTH	HEIGHT	SILVER	GOLD	SATIN NICKEL	STANDARD PAINT
3/8" CLEAR	CT-636	Slider 48" TO 59 1/2" return up to 30"	57 3/4"	\$2,136	\$2,278	\$2,467	\$2,893
		Slider 48" TO 59 1/2" return up to 36"		\$2,260	\$2,402	\$2,591	\$3,019
		Slider 60" TO 71 1/2" return up to 30"		\$2,395	\$2,506	\$2,724	\$3,154
		Slider 60" TO 71 1/2" return up to 36"		\$2,525	\$2,666	\$2,856	\$3,282

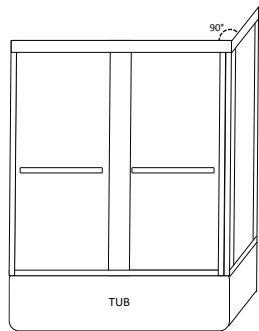

CTX-636- TALLER BYPASS TUB WITH 90° RETURN PANEL W/ 3/8" GLASS							
	MODEL	MIN TO MAX WIDTH	HEIGHT	SILVER	GOLD	SATIN NICKEL	STANDARD PAINT
3/8" CLEAR	CTX-636	Slider 48" TO 59 1/2" return up to 30"	62 3/4"	\$2,260	\$2,402	\$2,591	\$3,019
		Slider 48" TO 59 1/2" return up to 36"		\$2,390	\$2,531	\$2,773	\$3,147
		Slider 60" TO 71 1/2" return up to 30"		\$2,521	\$2,662	\$2,851	\$3,278
		Slider 60" TO 71 1/2" return up to 36"		\$2,655	\$2,797	\$2,986	\$3,412
	CTXX-636	Slider 54" TO 59 1/2" return up to 30"	66"	\$2,319	\$2,462	\$2,649	\$3,076
		Slider 54" TO 59 1/2" return up to 36"		\$2,452	\$2,594	\$2,781	\$3,209

Shaded models indicate that a strengthened header will be used due to excessive weight. This adds 3/8" to Height.

Anodized aluminum may vary in shade and color among extrusions.  
Color variance is considered within factory tolerances in the Anodizing Industry.

Available in Standard Paint

\* Buttress available

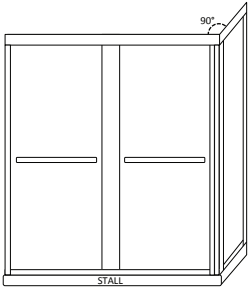

CS-1648- STALL BYPASS WITH 90° RETURN PANEL W/ 3/8" GLASS							
	MODEL	MIN TO MAX WIDTH	HEIGHT	SILVER	GOLD	SATIN NICKEL	STANDARD PAINT
3/8" CLEAR	CS-1648	Slider 36" TO 47 1/2" return up to 30"	70 3/4"	\$2,251	\$2,392	\$2,581	\$3,007
		Slider 36" TO 47 1/2" return up to 36"		\$2,390	\$2,531	\$2,721	\$3,147
		Slider 48" TO 59 1/2" return up to 30"		\$2,410	\$2,552	\$2,741	\$3,168
		Slider 48" TO 59 1/2" return up to 36"		\$2,551	\$2,691	\$2,883	\$3,309
		Slider 60" TO 65 1/2" return up to 30"		\$2,598	\$2,740	\$2,929	\$3,356
		Slider 60" TO 65 1/2" return up to 36"		\$2,744	\$2,885	\$3,075	\$3,500

Shaded models indicate that a strengthened header will be used due to excessive weight. This adds 3/8" to Height.

Anodized aluminum may vary in shade and color among extrusions.  
Color variance is considered within factory tolerances in the Anodizing Industry.

Available in Standard Paint

\* Buttruss available

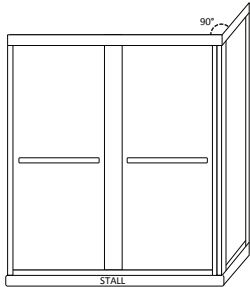

CSX-1648- TALLER STALL BYPASS WITH 90° RETURN PANEL W/ 3/8" GLASS							
	MODEL	MIN TO MAX WIDTH	HEIGHT	SILVER	GOLD	SATIN NICKEL	STANDARD PAINT
3/8" CLEAR	CSX-1648	Slider 36" TO 47 1/2" return up to 30"	76"	\$2,433	\$2,575	\$2,766	\$3,189
		Slider 36" TO 47 1/2" return up to 36"		\$2,581	\$2,722	\$2,913	\$3,338
		Slider 48" TO 59 1/2" return up to 30"		\$2,554	\$2,697	\$2,886	\$3,312
		Slider 48" TO 59 1/2" return up to 36"		\$2,704	\$2,845	\$3,036	\$3,462
		Slider 60" TO 65 1/2" return up to 30"		\$2,753	\$2,896	\$3,086	\$3,511
		Slider 60" TO 65 1/2" return up to 36"		\$2,906	\$3,050	\$3,240	\$3,665

Shaded models indicate that a strengthened header will be used due to excessive weight. This adds 3/8" to Height.

Anodized aluminum may vary in shade and color among extrusions.  
Color variance is considered within factory tolerances in the Anodizing Industry.

## SEMI-FRAMELESS PIVOT HINGE

### STANDARD FEATURES ON CENTEC HINGE

- Complete with reversible header allowing either round or flat profile.
- 6" C-Pull handle included in price
- 1/4" Clear tempered glass (1/4" stock Bubble glass is also available for many models/sizes—call for pricing)
- Built in aluminum drip pan with vinyl or a vinyl deflector
- 8" handles available, but require custom pricing. Please call for a quote.
- Custom sizes also available -- contact Century for pricing.
- Custom configurations are available for most CH units, including additional inline panels, buttress panels, angle cut panels or doors to follow the slope of the ceiling, etc. Please contact us for details.

**Available in Standard Paint**

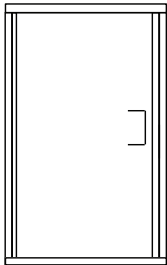

CH-70 SINGLE DOOR					
MODEL	MIN TO MAX WIDTH	HEIGHT	SILVER	SATIN NICKEL	STANDARD PAINT
CH-70-23 1/2	23 1/4" - 23 3/4"	72 3/4"	\$791	\$863	\$1,056
↓	↓				
CH-70-27	26 3/4" - 27 1/4"		\$797	\$901	\$1,060
CH-70-27 1/2	27 1/4" - 27 3/4"				
↓	↓				
CH-70-31	30 3/4" - 31 1/4"				

Standard Colors include: Pearl White, Oil Rubbed Bronze, Matte Black. Custom color matching is also available for most Centec models- please call for pricing.

Anodized aluminum may vary in shade and color among extrusions. Color variance is considered within factory tolerances in the Anodizing Industry.

Available in Standard Paint \* Buttress available

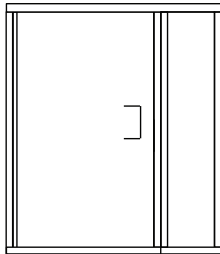

CH-1627 DOOR & PANEL					
MODEL	MIN TO MAX WIDTH	HEIGHT	SILVER	SATIN NICKEL	STANDARD PAINT
CH-1627-30	30-30 1/2"	72 3/4"	\$866	\$1,052	\$1,313
↓	↓				
CH-1627-35 1/2	35 1/2- 36"				
CH-1627-36	36- 36 1/2"		\$896	\$1,100	\$1,362
↓	↓				
CH-1627-41 1/2	41 1/2- 42"				
CH-1627-42	42- 42 1/2"				
↓	↓				
CH-1627-47 1/2	47 1/2- 48"				
CH-1627-48	48- 48 1/2"		\$945	\$1,149	\$1,411
↓	↓				
CH-1627-53 1/2	53 1/2- 54"				
CH-1627-54	54- 54 1/2"		\$995	\$1,198	\$1,462
↓	↓				
CH-1627-59 1/2	59 1/2- 60"	\$1,072	\$1,276	\$1,539	
↓	↓				
CH-1627-MOD	30-36"	68 1/4"	\$855	\$1,060	\$1,323
	36-42"		\$945	\$1,149	\$1,411
	42-48"		\$1,032	\$1,238	\$1,500
	48-54"		\$1,124	\$1,328	\$1,590
	54-60"		\$1,238	\$1,441	\$1,705
	30-36"	65 3/4"	\$915	\$1,120	\$1,381
	36-42"		\$995	\$1,198	\$1,462
	42-48"		\$1,073	\$1,277	\$1,540
	48-54"		\$1,154	\$1,358	\$1,619
	54-60"		\$1,255	\$1,461	\$1,723

\* Module prices in Clear represent stock glass, Door & Panel sizes cannot be specified. Buttress available on existing in-line panel, but requires custom glass- call for pricing

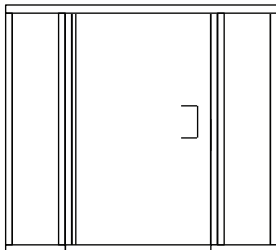

CH-1628- PANEL, DOOR, PANEL					
MODEL	MIN TO MAX WIDTH	HEIGHT	SILVER	SATIN NICKEL	STANDARD PAINT
CH-1628-36	36-36 1/2"	72 3/4"	\$1,053	\$1,350	\$1,745
↓	↓				
CH-1628-43 1/2	43 1/2-44"				
CH-1628-44	44- 44 1/2"		\$1,146	\$1,419	\$1,813
↓	↓				
CH-1628-51 1/2	51 1/2- 52"				
CH-1628-52	52- 52 1/2"				
↓	↓				
CH-1628-59 1/2	59 1/2- 60"				

Anodized aluminum may vary in shade and color among extrusions. Color variance is considered within factory tolerances in the Anodizing Industry.

>> Return to table of contents <<

Available in Standard Paint \* Buttruss available

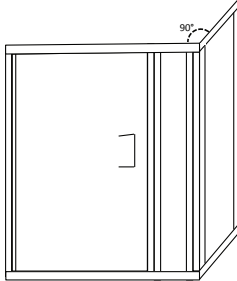

CH-1631- DOOR & PANEL WITH A 90° RETURN					
MODEL	MIN TO MAX WIDTH (centerline sizes up to)	HEIGHT	SILVER	SATIN NICKEL	STANDARD PAINT
CH-1631-1	34 1/2" X 34 1/2"	72 3/4"	\$1,628	\$1,831	\$2,388
CH-1631-2	40 1/2" X 34 1/2"		\$1,674	\$1,906	\$2,433
CH-1631-3	40 1/2" X 40 1/2"		\$1,775	\$2,040	\$2,533
CH-1631-4	48" X 36"		\$1,767	\$2,023	\$2,526
CH-1631-5	48" X 48"		\$1,967	\$2,231	\$2,711
CH-1631-6	54" X 36"		\$1,816	\$2,096	\$2,573
CH-1631-7	54" X 48"		\$2,015	\$2,304	\$2,771
CH-1631-8	60" X 36"		\$1,862	\$2,168	\$2,619
CH-1631-9	60" X 48"		\$2,061	\$2,377	\$2,820

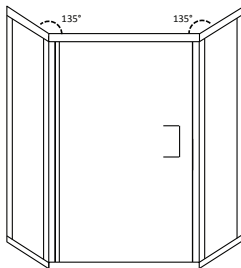

CH-1669- NEO-ANGLE PANEL, DOOR, PANEL					
MODEL	MIN TO MAX WIDTH (centerline dimensions)	HEIGHT	SILVER	SATIN NICKEL	STANDARD PAINT
CH-1669-1	16 1/2" x 24 1/4" x 16 1/2" (Fits 36"x 36" Base)	72 3/4"	\$1,284	\$1,544	\$2,074
CH-1669-2	16 1/2" x 25 1/4" x 16 1/2" (Fits 36"x 36" Base)				
CH-1669-3	17 1/2" x 24 1/4" x 17 1/2" (Fits 38"x 38" Base)				
CH-1669-4	18 1/2" x 24 1/4" x 18 1/2" (Fits 38"x 38" Base)				
CH-1669-NS1	Centerline up to 18 1/2" x 24 1/4" x 18 1/2"	65 5/8"	\$1,640	\$1,856	\$2,399
CH-1669-NS2	Centerline up to 22 1/2" x 26 1/4" x 22 1/2"		\$1,797	\$2,067	\$2,553
CH-1669-NS3	Centerline up to 30 1/2" x 28 1/4" x 30 1/2"		\$2,089	\$2,423	\$2,846
CH-1669 2/3	2/3 of a 135° Neo Angle Centerline up to 30" x 28"		\$1,643	\$1,900	\$2,402
CH-1669-LA	17 1/2" x 22 1/2" x 17 1/2" (Fits Lasco 1382 NAC)	70 3/8"	\$1,285	\$1,591	\$1,984
CH-1669-LA2P	17 1/2" x 23 7/8" x 17 1/2" (Fits Lasco 1382 NAC 2 Piece)		\$1,285	\$1,591	\$1,984
CH-1669-AK	15 1/2" x 27 1/2" x 15 1/2" (Fits Aker Neo)	70 3/8"	\$1,285	\$1,591	\$2,041
CH-1669-KO	15 1/2" x 26 1/2" x 15 1/2" (Fits Kohler Neo)		\$1,285	\$1,591	\$2,040
CH-1669-AG	18 3/4" x 23 1/4" x 18 3/4" (Fits Aqua Glass Neo Angle)		\$1,285	\$1,591	\$2,038

Anodized aluminum may vary in shade and color among extrusions. Color variance is considered within factory tolerances in the Anodizing Industry.

**SEMI-FRAMELESS CROSSOVER HINGE**

**STANDARD FEATURES ON CENTEC CROSSOVER HINGE**

- Complete with reversible header allowing either round or flat profile.
- 6" C-Pull handle included in price
- Aluminum patch hinges
- Custom configurations are available for most CHX units, including additional inline panels, buttress panels, angle cut panels or doors to follow the slope of the ceiling, etc. Please contact us for details.
- 1/4" Clear Tempered Glass
- Vinyl Deflector

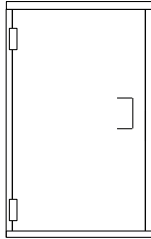

CHX-70 SINGLE DOOR				
MODEL	MIN TO MAX WIDTH (Centerline sizes up to)	HEIGHT	SILVER	SATIN NICKEL
CHX-70-23 1/4	23"- 23 1/2"	72 3/4" --- Available without header 70 7/8"	\$878	\$988
↓	↓			
CHX-70-26 3/4	26 1/2"- 27"			
CHX-70-27 1/4	27"- 27 1/2"			
↓	↓			
CHX-70-31 1/4	31"- 31 1/2"	\$936	\$1,046	

**\* Buttress available**

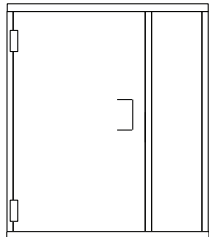

CHX-1627- DOOR & PANEL					
MODEL	MIN TO MAX WIDTH	HEIGHT	SILVER	SATIN NICKEL	
CHX-1627-30	30-30 1/2"	72 3/4"	\$967	\$1,189	
↓	↓				
CHX-1627-35 1/2	35 1/2- 36"				
CHX-1627-36	36- 36 1/2"				
↓	↓				
CHX-1627-41 1/2	41 1/2- 42"				
CHX-1627-42	42- 42 1/2"				
↓	↓				
CHX-1627-47 1/2	47 1/2- 48"				
CHX-1627-48	48- 48 1/2"				
↓	↓				
CHX-1627-53 1/2	53 1/2- 54"	68 1/4"	\$1,274	\$1,494	
CHX-1627-54	54- 54 1/2"				
↓	↓				
CHX-1627-59 1/2	59 1/2- 60"				
CHX-1627-MOD	30-36"		65 3/4"	\$1,008	\$1,230
	36-42"			\$1,108	\$1,329
	42-48"			\$1,208	\$1,430
	48-54"			\$1,307	\$1,529
	54-60"			\$1,432	\$1,652
	30-36"		65 3/4"	\$1,093	\$1,213
	36-42"	\$1,166		\$1,328	
	42-48"	\$1,243		\$1,440	
	48-54"	\$1,319		\$1,542	
	54-60"	\$1,396		\$1,616	

Anodized aluminum may vary in shade and color among extrusions.  
Color variance is considered within factory tolerances in the Anodizing Industry.

>> Return to table of contents <<

\* Buttruss available

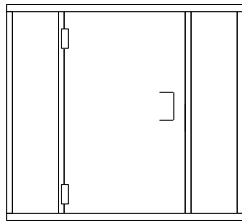

CHX-1628- DOOR, PANEL, DOOR				
MODEL	MIN TO MAX WIDTH	HEIGHT	SILVER	SATIN NICKEL
CHX-1628-36	36-36 1/2"	72 3/4"	\$1,137	\$1,469
↓	↓			
CHX-1628-43 1/2	43 1/2-44"			
CHX-1628-44	44- 44 1/2"			
↓	↓			
CHX-1628-51 1/2	51 1/2- 52"			
CHX-1628-52	52- 52 1/2"	\$1,199	\$1,532	
↓	↓			
CHX-1628-59 1/2	59 1/2- 60"	\$1,261	\$1,591	

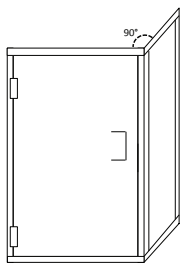

CHX-1630- DOOR WITH A 90° RETURN				
MODEL	MIN TO MAX WIDTH	HEIGHT	SILVER	SATIN NICKEL
CHX-1630-1	30" X 34 1/2"	72 3/4"	\$1,626	\$1,848
CHX-1630-2	30" X 36"		\$1,657	\$1,880
CHX-1630-3	30" X 40"		\$1,724	\$1,945
CHX-1630-4	30" X 48"		\$1,855	\$2,075

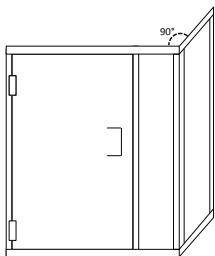

CHX-1631- DOOR & PANEL WITH A 90° RETURN				
MODEL	MIN TO MAX WIDTH (centerline up to)	HEIGHT	SILVER	SATIN NICKEL
CHX-1631-1	34 1/2" X 34 1/2"	72 3/4"	\$1,718	\$2,050
CHX-1631-2	40 1/2" X 34 1/2"		\$1,767	\$2,100
CHX-1631-3	40 1/2" X 40 1/2"		\$1,867	\$2,199
CHX-1631-4	48" X 36"		\$1,865	\$2,197
CHX-1631-5	48" X 48"		\$2,029	\$2,359
CHX-1631-6	54" X 36"		\$1,876	\$2,207
CHX-1631-7	54" X 48"		\$2,075	\$2,405
CHX-1631-8	60" X 36"		\$1,924	\$2,255
CHX-1631-9	60" X 48"		\$2,123	\$2,456

Anodized aluminum may vary in shade and color among extrusions. Color variance is considered within factory tolerances in the Anodizing Industry.

\* **Buttress available**

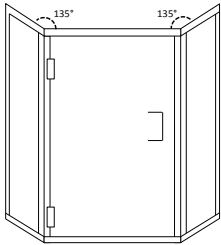

<b>CHX-1669- DOOR, PANEL, DOOR NEO-ANGLE</b>				
MODEL	MIN TO MAX WIDTH (centerline dimensions)	HEIGHT	SILVER	SATIN NICKEL
CHX-1669-1	16 1/2" x 24 1/4" x 16 1/2" (Fits 36"x 36" Base)	72 3/4"	\$1,314	\$1,544
CHX-1669-2	16 1/2" x 25 1/4" x 16 1/2" (Fits 36"x 36" Base)			
CHX-1669-3	17 1/2" x 24 1/4" x 17 1/2" (Fits 38"x 38" Base)			
CHX-1669-4	18 1/2" x 24 1/4" x 18 1/2" (Fits 38"x 38" Base)			
CHX-1669-NS1	Centerline up to 18 1/2" x 24 1/4" x 18 1/2"		\$1,564	\$1,824
CHX-1669-NS2	Centerline up to 22 1/2" x 26 1/4" x 22 1/2"		\$1,703	\$1,956
CHX-1669-NS3	Centerline up to 30 1/2" x 28 1/4" x 30 1/2"		\$1,978	\$2,224
CHX-1669 2/3	Two Thirds of a 135° Neo Angle up to 30" x 28"		\$1,587	\$1,845
CHX-1669-LA	17 1/2" x 22 1/2" x 17 1/2" (Fits Lasco 1382 NAC)	65 5/8"	\$1,595	\$1,881
CHX-1669-LA2P	17 1/2" x 23 7/8" x 17 1/2" (Fits Lasco 1382 NAC 2 Piece)			
CHX-1669-AK	15 1/2" x 27 1/2" x 15 1/2" (Fits Aker Neo)	70 3/8"	\$1,595	\$1,881
CHX-1669-KO	15 1/2" x 26 1/2" x 15 1/2" (Fits Kohler Neo)		\$1,595	\$1,881
CHX-1669-AG	18 3/4" x 23 1/4" x 18 3/4" (Fits Aqua Glass Neo Angle)		\$1,595	\$1,881

Anodized aluminum may vary in shade and color among extrusions.  
Color variance is considered within factory tolerances in the Anodizing Industry.

**AVAILABLE UPGRADES FOR 1/4" GLASS**

<b>Glass Patterns/Tints</b>	<b>Sq.Ft. List Price</b>
Low Iron	\$42
Niagara (Rain)	\$47
Stipolite (Pattern 62)	\$47
Starphire	\$42
Satin Etch	\$57
Reed	\$81
Clear	\$26
Spraylite	\$96

**AVAILABLE UPGRADES FOR 3/8" GLASS**

<b>Glass Patterns/Tints</b>	<b>Sq.Ft. List Price</b>
Low Iron	\$68
Niagara (Rain)	\$84
Stipolite (Pattern 62)	\$79
Starphire	\$68
Satin Etch	\$91
ShowerGuard	\$56
Low Iron ShowerGuard	\$114
Clear	\$42
Reed	\$113

\* Please call to check availability of ALL glass upgrades.

Prices shown are per square foot and are incremental to clear glass price, so can be added to the unit list price.

Formula for Square Feet:

Door Width (inches) X Door Height (inches) ÷144 = SF

Example: 28" x 80" = 2240 ÷ 144 = 15.55 SF (Round to whole number)

	<b>\$/ Sq Ft</b>
Diamon Fusion	\$10

Diamon Fusion is a one-time, chemical treatment that is applied to and absorbed by the glass in order to add a layer of protection to the glass, reducing the required cleaning time.

(APPLIED TO BOTH SIDES OF THE GLASS)

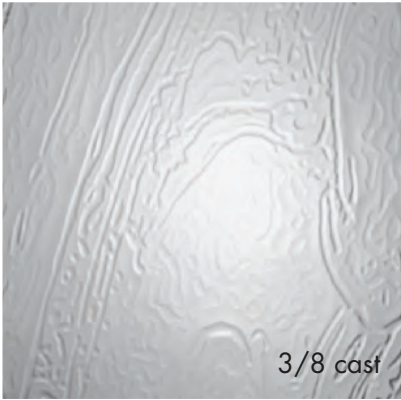

3/8 cast



1/4 & 3/8 niagara



1/4 & 3/8 stipolite  
(Pattern 62)



1/4 & 3/8 reeded



1/4 spraylite



satin etch





DIAMON-FUSION INTERNATIONAL  
"Innovation That Ignites Business"

The optional Diamon-Fusion treatment helps protect the glass from the build up of soap scum and hard water deposits and reduces cleaning time by 50%. Applied to both sides of the glass, a vapor mist fills the natural microscopic peaks and valleys in the glass with an ultra thin optically clear durable material making it easier to clean. Simply wipe down with a washcloth or squeegee after showering.



Customers ask for ShowerGuard glass by name because it's the first and best permanent protective shower glass on the market. Wipe-on, spray-on alternatives may need to be periodically re-applied after use. ShowerGuard is applied to one side of the glass during the manufacturing process. Only ShowerGuard has a lifetime limited warranty.

Available in Standard Paint

<b>AVAILABLE HANDLES FOR HINGED MODELS</b> (prices shown assume a set of 2 back to back handles)			
<b>DESCRIPTION</b>	<b>6"</b>	<b>8"</b>	<b>Samples</b>
<b>C-Pull</b>	\$70	\$210	
<b>Spindle</b>	\$225	\$263	
<b>Bow</b>	\$218	\$245	
<b>Circle</b>	\$263	N/A	
<b>Highline Flat</b>	\$288	\$346	
<b>Square (Taiga)</b>	\$212	\$190	
<b>Ladder</b>	\$149	\$196	
<b>Coda</b>	\$240	\$209	
<b>Symphony</b>	\$369	\$363	
<b>Aria</b>	\$573	\$613	
<b>Concerto</b>	\$369	\$453	









\* Additional handle styles available (including 8" handles)- please contact us for more details and pricing

\* Clamp On Handle Available for No Additional Charge

Anodized aluminum may vary in shade and color among extrusions.  
Color variance is considered within factory tolerances in the Anodizing Industry.

>> Return to table of contents <<

Available in Standard Paint

<b>AVAILABLE TOWEL BARS FOR SLIDER MODELS</b> (BARS AVAILABLE IN 15", 18", 21", 24", 27" & 30" LENGTHS, EXCEPT WHERE OTHERWISE NOTED)		
DESCRIPTION	SET OF 2 SINGLE-SIDED TOWEL BARS	SAMPLES
Modern	\$131	
Traditional	\$249	
Spindle	\$502	
Bow (18" & 24" only)	\$383	
Square (Taiga, 18" & 24" only)	\$246	
Aria (24" only)	\$476	
Coda (18" & 24" only)	\$386	
Symphony (24" & 30" only)	\$583	
Concerto (24" & 30" only)	\$583	

Anodized aluminum may vary in shade and color among extrusions. Color variance is considered within factory tolerances in the Anodizing Industry.

Additional towel bars are available, including back to back towel bars for hinged models. Please call for pricing.

Available in Standard Paint

AVAILABLE FINISHES	DESCRIPTION	PRICE
<b>Silver Anodized Aluminum</b>	Bright, chrome-like finish	Standard for all Centec models, except Select and Premier units
<b>Gold Anodized Aluminum</b> (Available for Slider)	This finish will vary in shade and color among extrusions, but is within the tolerances established by the anodizing industry.	\$45 per panel
<b>Satin Nickel Anodized Aluminum</b> (Available for Slider, CH, and CHX Models)	This finish will vary in shade and color among extrusions, but is within the tolerances established by the anodizing industry.	\$105 per panel
<b>Standard Paint (Available for Slider and CH Models)</b>	Standard Colors for a baked enamel painted finish: Pearl White, Matte Black, Oil Rubbed Bronze.	\$241 per panel
<b>Custom Color Matching (Available for Slider and CH Models)</b>	Custom Color Matching can be obtained by submitting a tile, fabric, or paint sample. If the samples are muddled or marbelized, you must pick a solid color within the sample to match; variations cannot be matched.	\$241 per panel + \$527 setup

Anodized aluminum may vary in shade and color among extrusions. Color variance is considered within factory tolerances in the Anodizing Industry.

Available in Standard Paint

DESCRIPTION	PRICE (TO BE ADDED TO LIST)
<b>Buttress (on existing panels)</b> (Charge to convert full height panel to buttress panel)	Slider in-line or return panels: \$92 added to list price
	Hinged unit return panels: \$92 added to list price
	Hinge unit in-line panels: \$12 per sq ft (Clear) (multiplied by sq footage of buttress panel)
<b>Notched Panel (for enclosures w/ a buttress(es))</b>	1/4" 2 sq ft or under (24x12):\$247, <i>plus custom glass</i>
	1/4" Over 2 sq ft (24x12):\$295, <i>plus custom glass</i>
	3/8" 2 sq ft or under (24x12):\$390, <i>plus custom glass</i>
	3/8" Over 2 sq ft (24x12):\$467, <i>plus custom glass</i>
<b>Frameless Mitered Corner (Glass with a 45° miter joining at the corner; no metal corner post)</b> <b>**Notched Panel is required- min 2 1/2" cline**</b>	\$263 per corner added, <i>plus custom glass</i>
<b>Special Angles, other than 135° Neo Angle Unit (1669):</b>	\$263 added to unit list price
<b>Angle Ceiling Enclosure</b> (glass cut to follow slope of the ceiling)	1/4": \$338, <i>plus custom glass</i>
	3/8": \$467, <i>plus custom glass</i>
<b>Crown Molding Header</b>	Hinged Doors: \$9 per ft
	Bypass Doors: \$11 per ft
<b>Additional Inline/ Buttress Inline Panels</b>	Up to 12": \$390 for Clear
	Up to 24": \$512 for Clear
<b>Angle Mount (units hitting a wall at an angle other than 90°; various configurations available based on application)</b>	Mounting to a 135° angled wall- add \$113 per mount
	Mounting to an angled wall other than 90° or 149° add \$263 per mount
<b>Special Width (for units wider than those specified in the price lists)</b>	\$113 per 6" over std width, <i>plus custom glass</i>
<b>Special Height (for units taller than those specified in the price lists)</b>	\$113 per 6" over std height, per panel, <i>plus custom glass</i>
<b>Cutdown (for units shorter than those specified in the price lists)</b>	\$75 per panel <i>plus custom glass</i>

Anodized aluminum may vary in shade and color among extrusions.  
 Color variance is considered within factory tolerances in the Anodizing Industry.

Available in Standard Paint

	DESCRIPTION	PRICE
<b>Straight Fillers (Slider or Hinged Models)</b>	Up to 1/2" filler to the wall or base	Add \$54 to list price, per jamb
	Up to 1" filler to the wall or base	Add \$67 to list price, per jamb
<b>Tapered Fillers (Slider or Hinged Models)</b>	Custom made filler cut per customer specification for out of plumb or out of level conditions	0-1" - Add \$104 to list price, per filler
		1-2" - Add \$204 to list price, per filler
		Over 2" - contact Century for a quote.

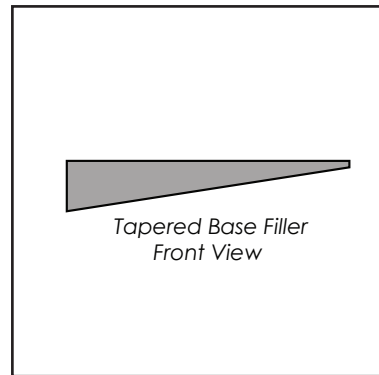
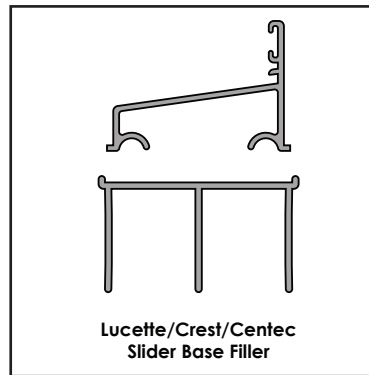
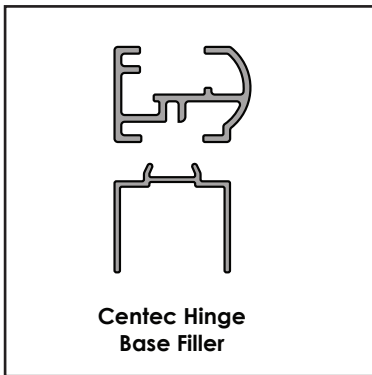
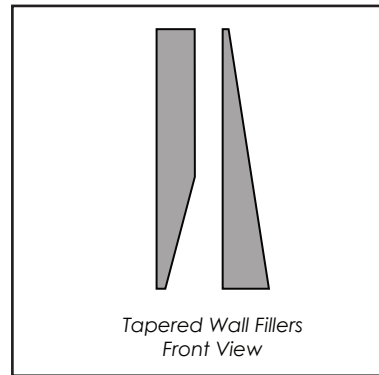
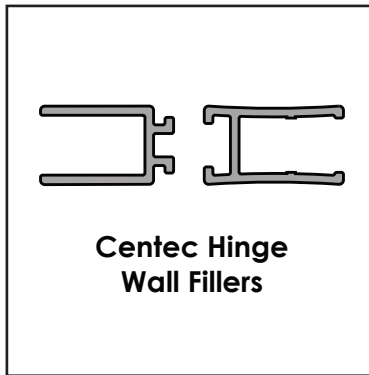
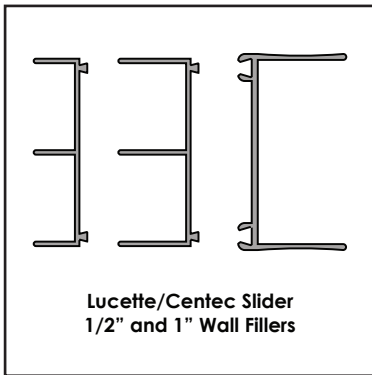

Anodized aluminum may vary in shade and color among extrusions.  
Color variance is considered within factory tolerances in the Anodizing Industry.